

5-Shelf Steel Storage Rack

with Particleboard Decking

MODEL NUMBERS:
DR723618G
DR724824G

IMPORTANT SAFETY INFORMATION

Read through this entire manual for important guidelines and instructions prior to assembly. Failure to follow these guidelines and instructions can result in property damage or serious personal injuries.

This unit should be placed on a level surface. Failure to do so can result in poor product performance or create a possible safety hazard. DO NOT CLIMB, STAND or USE THIS UNIT AS A LADDER. TO PREVENT TIPPING, ALWAYS SECURE TO A WALL WITH SUITABLE FASTENERS, NOT INCLUDED. DO NOT USE THIS UNIT TO STORE AQUARIUMS. CAUTION: CONTAINS SMALL PARTS, KEEP CHILDREN AWAY DURING INSTALLATION. USE TWO OR MORE PEOPLE TO ASSEMBLE AND MOVE THE UNIT TO AVOID INJURY. Do not use this unit for anything other than the manufacturer's intended purpose. Use care when working with metal parts, wear gloves for protection. Periodically inspect the unit to ensure brace/beam rivets are properly seated into post slots. Keep this manual for future reference.

Do not exceed the maximum weight capacity of 600 lbs (272 kg) for each shelf, not to exceed 3,000 lbs (1,361 kg) for the entire shelving unit. Evenly distribute weight loads across entire shelf surface. Always store larger, heavier items on the bottom levels and small lighter items on the upper levels.

WARRANTY

Edsal Manufacturing Company, LLC products are guaranteed for a period of one (1) year from the date of purchase. The SOLE AND EXCLUSIVE REMEDY for such defects is the repair or replacement of a defective product or parts thereof by Edsal Manufacturing Company, LLC or, at Edsal Manufacturing Company, LLC option, refund of the purchase price upon return of the item to Edsal Manufacturing Company, LLC. This warranty shall not apply in the event the products are damaged as a result of misuse, neglect, accident, moisture, improper application, improper assembly, or assembly not in conformity with the instructions of Edsal Manufacturing Company, LLC, failure to abide by safety precautions prescribed by Edsal Manufacturing Company, LLC or modification or repair by persons not authorized by Edsal Manufacturing Company, LLC.

PARTS

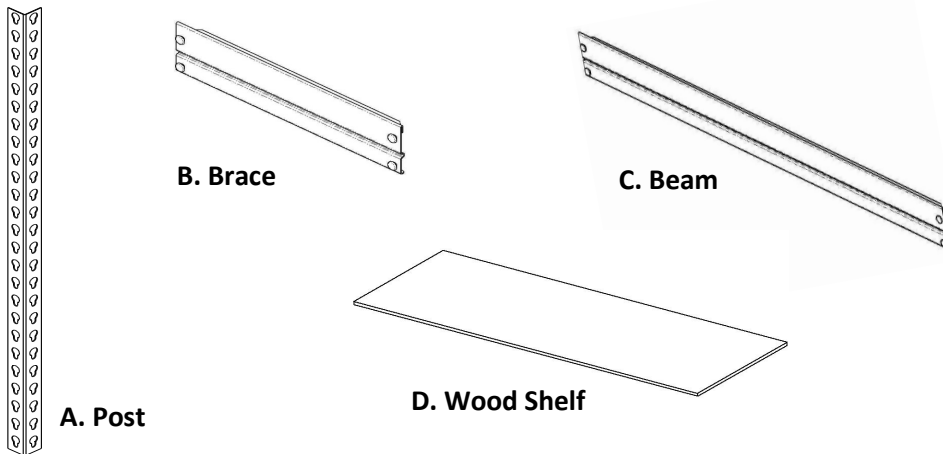

Model DR723618 : 72"H x 18"D x 36"W		
Description	Qty	Part Number
A. Post	8	URPS36-GRY
B. Brace	10	CRBR3618-GRY
C. Beam	10	CRBM36-GRY
D. Wood Shelf	5	RPB31836

Model DR724824 : 72"H x 24"D x 48"W		
Description	Qty	Part Number
A. Post	8	URPS36-GRY
B. Brace	10	CRBR24-GRY
C. Beam	10	CRBM48-GRY
D. Wood Shelf	5	RPB32448

GENERAL INSTRUCTIONS

Assembly is done with the rivets of the beams and braces fitting into the slots of the post. A rubber mallet may be used on the beams and braces to seat the rivets properly. A hammer can also be used, providing one uses a cloth or a block of wood between the hammer head and the parts to prevent damage. Tap gently and be sure the rivets are straight and fully engaged.

Should you have any comments, damage, missing parts, or problems with assembly of this unit contact us:

Chat: www.edsal.com/chat or www.edsal.com/contact

Email: support@edsal.com

Phone: 773-475-3131

Edsal Manufacturing Co. LLC
1555 W. 44th Street
Chicago, IL 60609

US Patents & Patents Pending

To obtain replacement parts please provide: Model Number, Part Number & Description, Location Purchased, and Date Purchased

Rev: C050420

ASSEMBLY INSTRUCTIONS

Step

1

Figure B

Posts are directional. The narrow end of the slots must

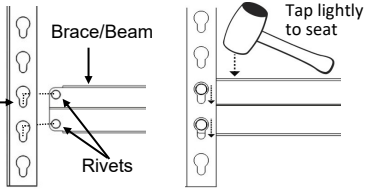

Figure A

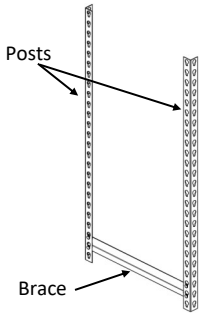
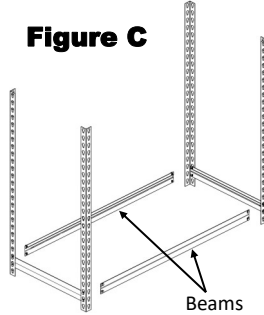

Figure C



Assemble two (2) post with one (1) brace. Skipping one slot from the bottom of the post (see figure A), place the rivets into post with the narrow end of the slots pointing down, and with the shelf ledge of the brace facing up (see figure B). Tap lightly on the top edge of the brace to seat rivets. Repeat with two (2) post and one (1) brace. Next assemble the two (2) post units with two (2) beams, skipping one slot from the bottom of the post (see figure C). Place the rivets into post with the narrow end of the slots pointing down, and with the shelf ledge of the brace facing up (see figure B). Tap lightly on the top edge of the beam to seat rivets.

Step

2

Figure D

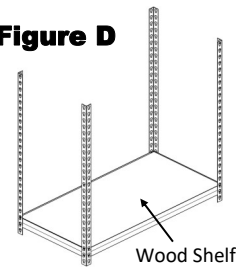
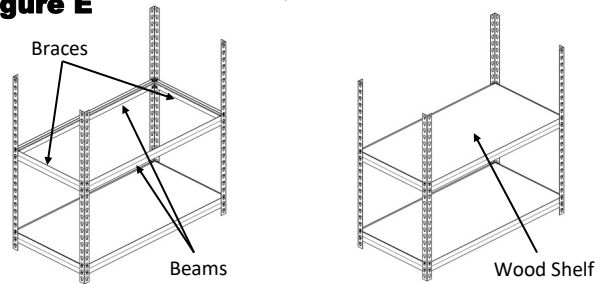

Figure E



Add a wood shelf to the level previously built (see Figure D), then continue working by adding the second level using two (2) beams and two (2) braces in the post slots of your desired location (see Figure E). Again, place the rivets of the beams and braces into the post slots with the shelf ledge facing up and tap lightly to seat the rivets. Add a wood shelf to the second level.

Step

3

Figure F

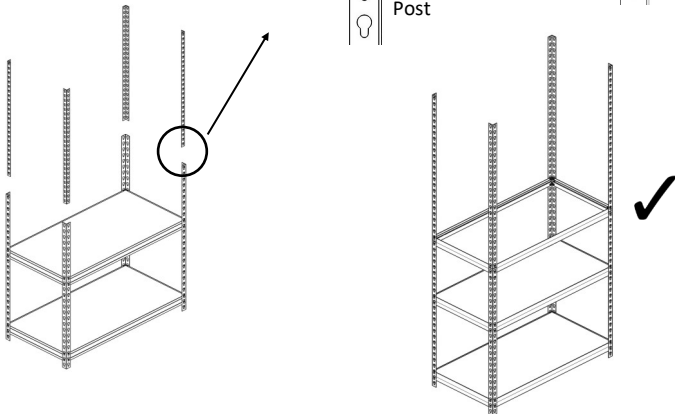
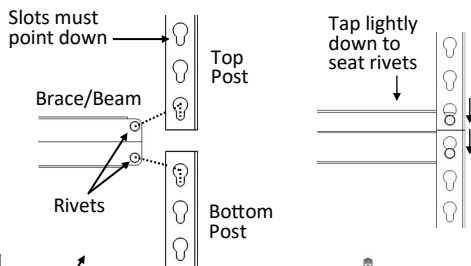

Assemble the top four post to the bottom four posts by using two (2) beams and two (2) braces. One (1) rivet from each beam and brace must be placed in the top hole of the bottom post, and the bottom hole of the top post (see figure F). After all beams and braces are in place, tap lightly to properly seat rivets.

Step

4

Figure G

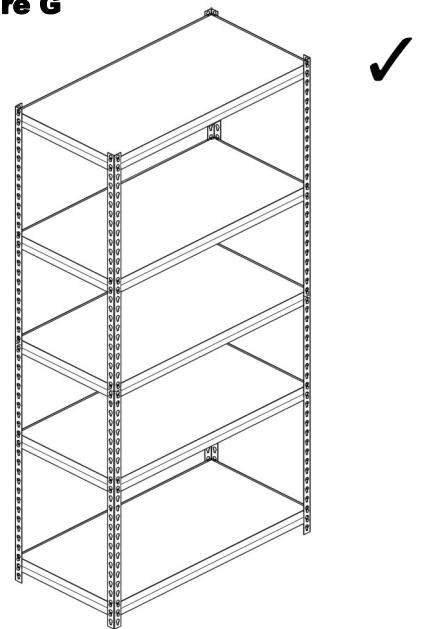

Add a wood shelf to the previously built level, then continue by adding the fourth and fifth level to the unit using two (2) beams and two (2) braces per level. Tap lightly to properly seat the rivets and add the final wood shelves to the unit (see figure G).